













Especificações (Luminárias da série)

	Isolamento elétrico	CI
	Tensão (V)	220-240V
Hz	Frequência (Hz)	50/60Hz
ϕ	Fator de Potência (Cos fi)	>0,9
	Regulação	Não

	Índice de estanqueidade IP	IP65
	IK Proteção contra impactos	IK06
	Cor do corpo	7045
	Material Difusor	VT-T
	Corpo	Al

K	Temperatura de cor	5000K
	CRI Índice de repr. cromática	>80
	Angulo de abertura	100°

	Dimensão	180x240x56mm
---	-----------------	--------------

	Temperatura de trabalho	-
---	--------------------------------	---



ϕ_{LUM}	Fluxo (lm)	4 516lm
--------------	-------------------	---------

	Vida	(L70B50>)25.000h
---	-------------	------------------

	Vida	(L70B50>)25.000h
---	-------------	------------------

Referências



	W	ϕ_{LUM}	K		
504782	50W	4516lm	5000K 5000K	Cinza escuro	180x240x56mm

Dimensões

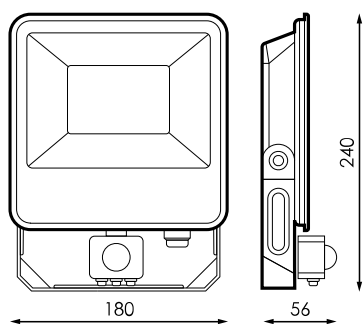

Fotometria



Informacje



Hasta fin de existencias