













## Especificações (Luminárias da série)

	<b>Isolamento elétrico</b>	Cl
	<b>Tensão (V)</b>	220-240V
<b>Hz</b>	<b>Frequência (Hz)</b>	50/60Hz
$\phi$	<b>Fator de Potência (Cos fi)</b>	>0,9
	<b>Regulação</b>	Não

	<b>Índice de estanqueidade IP</b>	IP65
	<b>IK Proteção contra impactos</b>	IK06
	<b>Cor do corpo</b>	7045
	<b>Material Difusor</b>	VT-T
	<b>Corpo</b>	Al

<b>K</b>	<b>Temperatura de cor</b>	5000K
	<b>CRI Índice de repr. cromática</b>	>80
	<b>Angulo de abertura</b>	100°

	<b>Dimensão</b>	135x186x56mm
---	-----------------	--------------

	<b>Temperatura de trabalho</b>	-
---	--------------------------------	---



$\phi_{LUM}$	<b>Fluxo (lm)</b>	2 743lm
--------------	-------------------	---------

	<b>Vida</b>	(L70B50>)25.000h
---	-------------	------------------

	<b>Vida</b>	(L70B50>)25.000h
---	-------------	------------------

**Referências**



	W	$\phi_{LUM}$	K		
<b>504775</b>	30W	2743lm	5000K 5000K	Cinza escuro	135x186x56mm

**Dimensões**

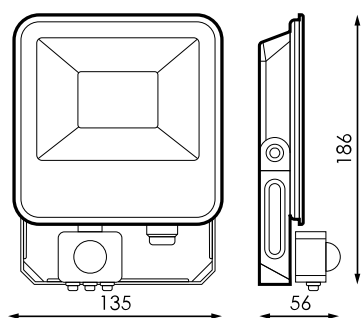

**Fotometria**



**Informacje**



Hasta fin de existencias